



Diba

Fluid Intelligence

Dibafit

Connection Systems

Click-N-Seal® Micro 6-40 Fitting
See Page 3

NEW

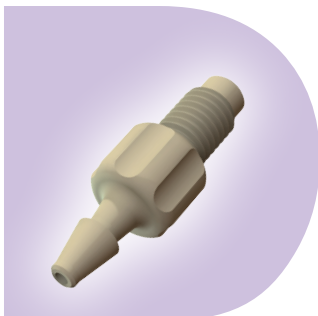

www.dibaind.com

Contents

2 Selection Guide

3 Look What's New! 6-40 Fittings!

4 Click-N-Seal® Self-Torquing Fittings

Hand-tight fittings with the unique torque-control system

4 Click-N-Seal® Flares

Hand-tight fittings for flared tubing connections

5 Click-N-Seal® Self-Torquing Adaptors

Hand-tight thread to barb adaptors with the unique torque-control system

5 Click-N-Seal® 10-32 Fittings

6 Dibafit™ Type P Ferrule System

Omni-Lok™ & Click-N-Seal® fittings with PTFE ferrules, pressure rated up to 1000 psi

7 FEP Sample Loops & Mixing Coils

8 Dibafit™ Type S Ferrule System

Flangeless Omni-Lok™ & Click-N-Seal® fittings with ETFE or PEEK™ ferrules, pressure rated up to 500 psi

10 Dibafit™ Inverted Cone System

Flangeless Omni-Lok™ & Click-N-Seal® fittings with PTFE inverted cones, pressure rated up to 250 psi

12 Dibafit™ Gripper Fittings

Chemically inert flangeless fittings, pressure rated up to 1000 psi

13 Adaptors, Couplings & Connectors

14 Barbed Adaptors

Thread to barb adaptors in PEEK™ or Acetal

15 Microbarb®

Low-carryover connection for softwall to semi-rigid tubing

15 Tubing Extrusion

SELECTION GUIDE

1. Locate the outer diameter (OD) of the tubing you wish to connect in the left-hand column;
2. Choose the maximum pressure rating you require in the second column;
3. Locate the type of threads your port has in the top row;
4. Choose between fingertight or torque-controlled;
5. The resulting cell contains the product name best suited to your application. Full product details and ordering information for each system can be found in the relevant section of the catalog.

TUBE
OD

MAX
PRESSURE

PORT THREADS

	PSI	BAR	6-40 NEW		10-32	¼"-28 UNF		M6		⅜"-24 UNF
			FINGERTIGHT	TORQUE-CONTROLLED	TORQUE-CONTROLLED	FINGERTIGHT	TORQUE-CONTROLLED	FINGERTIGHT	TORQUE-CONTROLLED	FINGERTIGHT
⅛"	50	3		Click-N-Seal® Micro 6-40 pg 3	Click-N-Seal® 10-32 pg 5					
	250	17				Omni-Lok™ Inverted Cone pg 10	Click-N-Seal® Inverted Cone pg 10	Omni-Lok™ Inverted Cone pg 10	Click-N-Seal® Inverted Cone pg 10	
	500	34	Omni-Lok™ 6-40 pg 3			Omni-Lok™ Type S pg 8	Click-N-Seal® Type S pg 8	Omni-Lok™ Type S pg 8	Click-N-Seal® Type S pg 8	
	1000	69				Omni-Lok™ Type P pg 6	Click-N-Seal® Type P pg 6	Omni-Lok™ Type P pg 6	Click-N-Seal® Type P pg 6	
	2000	138			Click-N-Seal® 10-32 Cone Tip pg 5					
	2500	172			Click-N-Seal® 10-32 Type S Ferrule pg 5					
2.0mm	250	17				Omni-Lok™ Inverted Cone pg 10	Click-N-Seal® Inverted Cone pg 10	Omni-Lok™ Inverted Cone pg 10	Click-N-Seal® Inverted Cone pg 10	
2.5mm	250	17				Omni-Lok™ Inverted Cone pg 10	Click-N-Seal® Inverted Cone pg 10	Omni-Lok™ Inverted Cone pg 10	Click-N-Seal® Inverted Cone pg 10	
3.0mm	250	17				Omni-Lok™ Inverted Cone pg 10	Click-N-Seal® Inverted Cone pg 10	Omni-Lok™ Inverted Cone pg 10	Click-N-Seal® Inverted Cone pg 10	
⅜"	250	17				Omni-Lok™ Inverted Cone pg 10	Click-N-Seal® Inverted Cone pg 10	Omni-Lok™ Inverted Cone pg 10	Click-N-Seal® Inverted Cone pg 10	
	500	34				Omni-Lok™ Type S pg 8	Click-N-Seal® Type S pg 8	Omni-Lok™ Type S pg 8	Click-N-Seal® Type S pg 8	
	1000	69				Omni-Lok™ Type P pg 6	Click-N-Seal® Type P pg 6	Omni-Lok™ Type P pg 6	Click-N-Seal® Type P pg 6	
⅝"	30	2								Omni-Lok™ Inverted Cone pg 10
	120	8								Omni-Lok™ Type S (ETFE) pg 8
	200	14								Omni-Lok™ Type S (PEEK™) pg 8
										Omni-Lok™ Type P pg 6

Look What's **NEW**

Click-N-Seal® Micro 6-40 Fitting

The new Click-N-Seal® Micro 6-40 fitting provides torque control in the smallest spaces

The Diba Click-N-Seal® Micro 6-40 fitting, ferrule and flare solutions quickly and easily connect 1/16" tube into 6-40 threaded ports, making them ideal for systems that require smaller fluid connections. They ensure leak-free connections without risk of over-tightening.

- For microfluidics applications
- PEEK™ construction
- Pressure rating up to 50 psi (3 bar)
- Retains 1/16" OD tubing

Click-N-Seal® offers a unique system for hand-tight fittings. As the fitting is tightened, the resistance of the cap increases until the correct torque is reached, at which point, the cap clicks. The user is able to hand-tighten the fittings without tools or guesswork and be confident that the fitting is properly seated, creating a secure seal. The fitting can be unscrewed and reused.

NEW Ordering Information				
CLICK-N-SEAL® MICRO FOR 1/16" OD TUBING / 6-40 THREAD				
PART NUMBER	MATERIAL	COLOR	THREAD	QTY
008NF16-KT9L	PEEK™	Natural	6-40	10 pk
008NF16-KT9B	PEEK™	Black	6-40	10 pk
008NF16-KT9R	PEEK™	Red	6-40	10 pk

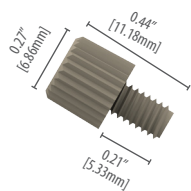

008NF16-KT9X
Click-N-Seal® Micro
6-40 fitting

6-40 Regular Fittings

The Diba 6-40 fitting and ferrule solution for quick and easy connection of 1/16" tube into a 6-40 threaded port

- For microfluidics applications
- Pressure rating up to 500 psi (34 bar)
- PEEK™ ferrule insert and 316 stainless steel case
- PEEK™ 6-40 threaded fitting
- Direct replacement for Lee Minstac™ ferrules and Upchurch 6-40 Super Flangeless™ ferrules and Tintytight™ (Trademarks owned by The Lee Company and IDEX Health and Science LLC, respectively)
- Retains 1/16" OD PTFE tube with 0.3, 0.5 or 0.8mm bore

The Omni-Lok™ Type S fitting system uses a two-piece ferrule which fits permanently to the outside of the tubing. Two-part ferrules consist of an inner PEEK™ sealing surface surrounded by a stainless steel lock ring with only the inner portion in the fluid path. The fitting can spin freely, eliminating tubing twist. A recess in the fitting houses the ferrule, allowing maximum thread engagement with the port. This ensures the system stays sealed up to 500 psi (33 bar) pressure.

NEW Ordering Information		
FERRULES FOR 1/16" OD TUBING / 6-40 THREAD		
PART NUMBER	DESCRIPTION	QTY
008FK16-03C9L	PEEK™ ferrule; taper port, 0.3mm through hole	10 pk
008FK16-05C9L	PEEK™ ferrule; taper port, 0.5mm through hole	10 pk
008FK16-08C9L	PEEK™ ferrule; taper port, 0.8mm through hole	10 pk
008FK16-F9L	PEEK™ ferrule; flat port, and SS lock ring	10 pk

OMNI-LOK™ FITTINGS FOR 1/16" OD TUBING / 6-40 THREAD				
PART NUMBER	MATERIAL	COLOR	THREAD	QTY
008NF16-KC9L	PEEK™	Natural	6-40	10 pk

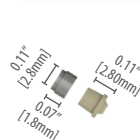

008FK16-XXC9L
Type S ferrule, PEEK™
taper port/conical bottom

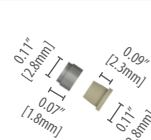

008FK16-F9L
Type S ferrule, PEEK™
flat port/ flat bottom

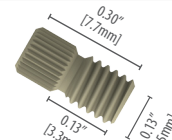

008NF16-KC9L
Omni-Lok™ fitting for 1/16" OD tubing

Standard Tubing Assemblies



Diba's offerings of in-stock standard tubing assemblies are ideal for OEMs and engineers interested in high quality, quick-turnaround components to accelerate the design phase of projects. The standard tubing assemblies feature Diba's proprietary flared ends to minimize dead volume and Click-N-Seal® fittings for secure, torque-adjusted connections every time. By using Diba standard tubing assemblies, you can:

- Accelerate bread boarding or prototyping
- Eliminate the lead time normally required for custom assemblies
- Bypass cumbersome component assembly
- Reduce the cost of custom parts in small quantities
- Eliminate the risk of over- or under-torquing the fitting
- Ensure quality connections throughout the design phase

Ordering information

STANDARD TUBING ASSEMBLIES				
PART NUMBER	DESCRIPTION	TUBING	ID/OD	LENGTH
DB200-15046	6-40 Fitting with Flare	PTFE	.031" x .062"	12"
DB200-15047	CNS PLUS with Flare & washer	FEP	.030" x .062"	24"
DB200-15048	CNS PLUS with Flare & washer	FEP	.062" x .125"	24"
DB200-15049	CNS PLUS with Flare & washer	PTFE	.031" x .062"	24"
DB200-15050	CNS PLUS with Flare & washer	PTFE	.062" x .125"	24"
DB200-15051	CNS PLUS with gripper Ferrule	PTFE	.031" x .062"	24"
DB200-15052	CNS Regular with Flare & washer	PTFE	.031" x .062"	24"
DB200-15053	CNS Regular with Flare & washer	PTFE	.062" x .125"	24"
DB200-15054	CNS ULTRA with Flare	PTFE	.031" x .062"	24"
DB200-15055	CNS ULTRA with Flare	PTFE	.062" x .125"	24"
DB200-15056	Microbarb with soft tubing	SILICONE	.030" x .093"	3"

Click-N-Seal® Self-Torquing Fittings

Hand-tight fittings for flared or ferrule connections with the unique torque-control system

- Available in Polycarbonate, Acetal or PEEK™
- For 1/16", 1/8" or 3/16" OD semi-rigid tubing e.g. PTFE, ETFE, FEP
- For flat-bottom 1/4"-28 UNF, M6 ports or 10-32 thread

Click-N-Seal® offers a unique system for hand-tight fittings. As the fitting is tightened, the resistance of the cap increases until the correct torque is reached; at which point, the cap clicks. The user is able to hand-tighten the fittings without tools or guesswork and be confident that the fitting is properly seated, creating a secure seal. The fitting can be unscrewed and reused.

Click-N-Seal® fittings are available in polycarbonate, acetal and PEEK™ and in standard or compact head designs.

Click-N-Seal® Ultra combines the unique torque-control of Click-N-Seal® with a compact head design and robust PEEK™ construction. For enhanced chemical resistance and a space-saving design, Click-N-Seal® Ultra is the product of choice. Now available with 10-32 threads in flat-bottom and taper designs.

Click-N-Seal® fittings - Standard, Plus and Ultra are compatible with any of the Dibaft™ ferrule types and with Dibaft™ inverted cones. Simply select the ferrule system that offers the pressure rating you require and then pair the appropriate ferrule with a Click-N-Seal®, Click-N-Seal® Plus or Click-N-Seal® Ultra fitting.

Whichever Click-N-Seal® system you choose, the result is a fitting system offering the best pressure and chemical compatibility for your application, plus the security of a fitting that is always tightened to the correct torque.

Flares

Diba has developed a unique way to form plastic tubing such as PTFE, FEP, LDPE, PEEK, etc. which creates a seal against a flat bottom port. Typical port sizes for which we flare the tubing are 1/4-28, 10-32, M6 and 6-40. A seal is created by compressing the flared portion of the tube against the flat bottom of the port with a plastic or stainless steel fitting. This type of connection is often used for precision fluid lines that handle samples and reagents in analyzers. Flares ensure that the connection is leak-free and also minimizes carryover.



Click-N-Seal® fittings for flared tubing provide a seal with only the tube material in the fluid path. The integrity of the seal depends on the quality of the flare produced. For leak-free superior flares, we recommend a Diba custom tubing assembly. For the ultimate in flared tubing connections, contact Diba for custom assemblies, including flared PEEK™ tubes.

Operating Pressures

Type P ferrule SS case; 1/16", 1/8" OD tube	1000 psi (69 bar)
Type P ferrule PEEK™ case; 1/16" OD tube	800 psi (56 bar)
Type P ferrule PEEK™ case; 1/8" OD tube	600 psi (42 bar)
with Type S ferrule	500 psi (34 bar)
with Inverted Cone	250 psi (17 bar)

Click-N-Seal® Fittings For Flares

Click-N-Seal® fittings for flared tubing enable you to create a ferrule-free connection and are offered in three different bore sizes - simply choose the size that best matches your tube OD. We recommend the use of a washer to ensure the flare seals correctly. An o-ring may also be necessary to ensure the fitting seats correctly in deeper ports and in this case a second washer should be used between the o-ring and the fitting.

Ordering information

CLICK-N-SEAL® FITTINGS FOR FLARED TUBING UP TO 1/16" OD

PART NUMBER	MATERIAL	COLOR	THREAD	QTY
008NG16-CS5B	PC	Black	1/4-28	10 pk
008NG16-CS5H	PC	White	1/4-28	10 pk
008NG16-CS5R	PC	Red	1/4-28	10 pk
008NG16-CS6B	PC	Black	M6	10 pk
008NG16-CS6H	PC	White	M6	10 pk
008NG16-CS6R	PC	Red	M6	10 pk

CLICK-N-SEAL® PLUS FITTINGS FOR FLARED TUBING UP TO 1/16" OD

PART NUMBER	MATERIAL	COLOR	THREAD	QTY
008NG16-AT5H	Acetal	White	1/4-28	10 pk
008NG16-AT6H	Acetal	White	M6	10 pk

CLICK-N-SEAL® ULTRA FITTINGS FOR FLARED TUBING UP TO 1/16" OD

PART NUMBER	MATERIAL	COLOR	THREAD	QTY
008NG16-KT5L	PEEK™	Natural	1/4-28	10 pk
008NG16-KT4L	PEEK™	Natural	10-32	10 pk

CLICK-N-SEAL® FITTINGS FOR FLARED TUBING 1.6MM TO 2.5MM OD

PART NUMBER	MATERIAL	COLOR	THREAD	QTY
008NG25-CS5B	PC	Black	1/4-28	10 pk
008NG25-CS5H	PC	White	1/4-28	10 pk
008NG25-CS5R	PC	Red	1/4-28	10 pk
008NG25-CS6B	PC	Black	M6	10 pk
008NG25-CS6H	PC	White	M6	10 pk
008NG25-CS6R	PC	Red	M6	10 pk

CLICK-N-SEAL® PLUS FITTINGS FOR FLARED TUBING 1.6MM TO 2.5MM OD

PART NUMBER	MATERIAL	COLOR	THREAD	QTY
008NG25-AT5H	Acetal	White	1/4-28	10 pk
008NG25-AT6H	Acetal	White	M6	10 pk

CLICK-N-SEAL® ULTRA FITTINGS FOR FLARED TUBING 1.6MM TO 2.5MM OD

PART NUMBER	MATERIAL	COLOR	THREAD	QTY
008NG25-KT5L	PEEK™	Natural	1/4-28	10 pk

CLICK-N-SEAL® FITTINGS FOR FLARED TUBING 2.5MM- 1/8" OD

PART NUMBER	MATERIAL	COLOR	THREAD	QTY
008NG32-CS5B	PC	Black	1/4-28	10 pk
008NG32-CS5H	PC	White	1/4-28	10 pk
008NG32-CS5R	PC	Red	1/4-28	10 pk
008NG32-CS6B	PC	Black	M6	10 pk
008NG32-CS6H	PC	White	M6	10 pk
008NG32-CS6R	PC	Red	M6	10 pk

CLICK-N-SEAL® PLUS FITTINGS FOR FLARED TUBING 2.5MM TO 1/8" OD

PART NUMBER	MATERIAL	COLOR	THREAD	QTY
008NG32-AT5H	Acetal	White	1/4-28	10 pk
008NG32-AT6H	Acetal	White	M6	10 pk

CLICK-N-SEAL® ULTRA FITTINGS FOR FLARED TUBING 2.5MM TO 1/8" OD

PART NUMBER	MATERIAL	COLOR	THREAD	QTY
008NG32-KT5L	PEEK™	Natural	1/4-28	10 pk

WASHER & O-RING KITS

PART NUMBER	DESCRIPTION	QTY
008FLK-16M	2 x PEEK™ washer & 1 x FKM/FFM O-ring for 1/16"	10 pk
008FLK-25M	2 x PEEK™ washer & 1 x FKM/FFM O-ring for 2.5MM	10 pk
008FLK-32M	2 x PEEK™ washer & 1 x FKM/FFM O-ring for 1/8"	10 pk

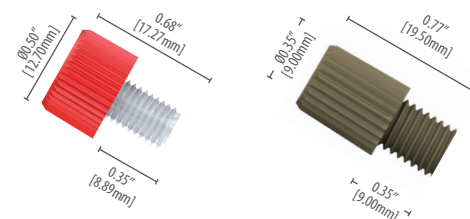

008NG16-CS/xx¹
Click-N-Seal® standard fitting
for 1/16" OD tubing

008NG16-ATxx¹/KT5L
Click-N-Seal® Plus/ Ultra fitting
for 1/16" OD tubing

¹The dimensions shown apply to all variants within the product group.

Click-N-Seal® Self-Torquing Adaptors

Thread to barb connections that can't be overtightened!

- For 1/16, 1/8 or 5/32" ID softwall tubing
- For 1/4"-28 UNF or M6 threaded ports
- Re-useable and reliable

Click-N-Seal® allows you to feel and hear when the fitting is properly installed, giving an audible click when the correct torque is reached. This thread to barb adaptor version enables connection of softwall tubing to a threaded port.

Ordering information

CLICK-N-SEAL® MALE 1/4"-28 UNF TO BARB ADAPTOR					
PART NUMBER	MATERIAL	COLOR	THREAD	TUBE ID	QTY
008NB16-CS5B	PC	Black	1/4-28 M	1/16" (1.57mm)	10 pk
008NB16-CS5H	PC	White	1/4-28 M	1/16" (1.57mm)	10 pk
008NB16-CS5R	PC	Red	1/4-28 M	1/16" (1.57mm)	10 pk
008NB16-CS6B	PC	Black	M6	1/16" (1.57mm)	10 pk
008NB16-CS6H	PC	White	M6	1/16" (1.57mm)	10 pk
008NB16-CS6R	PC	Red	M6	1/16" (1.57mm)	10 pk
008NB32-CS5B	PC	Black	1/4-28 M	1/8" (3.2mm)	10 pk
008NB32-CS5H	PC	White	1/4-28 M	1/8" (3.2mm)	10 pk
008NB32-CS5R	PC	Red	1/4-28 M	1/8" (3.2mm)	10 pk
008NB32-CS6B	PC	Black	M6	1/8" (3.2mm)	10 pk
008NB32-CS6H	PC	White	M6	1/8" (3.2mm)	10 pk
008NB32-CS6R	PC	Red	M6	1/8" (3.2mm)	10 pk
008NB40-CS5B	PC	Black	1/4-28 M	5/32" (4.0mm)	10 pk
008NB40-CS5H	PC	White	1/4-28 M	5/32" (4.0mm)	10 pk
008NB40-CS5R	PC	Red	1/4-28 M	5/32" (4.0mm)	10 pk
CLICK-N-SEAL® ULTRA MALE 1/4"-28 UNF TO BARB ADAPTOR					
PART NUMBER	MATERIAL	COLOR	THREAD	TUBE ID	QTY
008NB16-KT5L	PEEK™	Natural	1/4-28 M	1/16" (1.57mm)	10 pk
008NB16-KT6L	PEEK™	Natural	M6	1/16" (1.57mm)	10 pk
008NB32-KT5L	PEEK™	Natural	1/4-28 M	1/8" (3.2mm)	10 pk
008NB32-KT6L	PEEK™	Natural	M6	1/8" (3.2mm)	10 pk

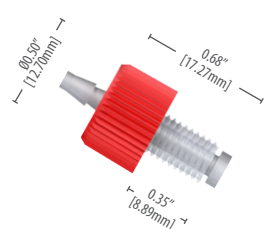

008NBxx¹-CS Series
Click-N-Seal® Thread to Barb

¹The dimensions shown apply to all variants within the product group. Barb diameters and lengths vary according to the ID of tube.

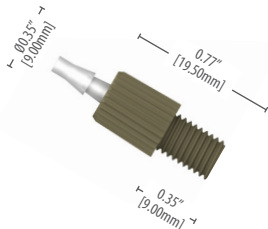

008NBxx¹-KT Series
Click-N-Seal® Ultra Thread to Barb

Click-N-Seal® Wrenches

Made of aluminum, Diba's Click-N-Seal® wrenches are ideal when working in spaces where access is limited.



DB100-13200
Click-N-Seal® Wrench



DB100-13309
Click-N-Seal® Wrench

10-32 Click-N-Seal® Ultra Fittings

The 10-32 Cone-Tip Click-N-Seal® fitting solution for quick and easy connection of 1/16" tube into a 10-32 conical port

- For HPLC type ports
- Pressure rating up to 2000 psi (138 bar)
- PEEK™ construction
- 10-32 thread with cone-tip suitable for HPLC type ports
- Retains 1/16" OD PTFE, ETFE, FEP, PEEK™ and other semi-rigid tubing

Click-N-Seal® offers a unique system for hand-tight fittings. As the fitting is tightened, the resistance of the cap increases until the correct torque is reached; at which point, the cap clicks. The user is able to hand-tighten the fittings without tools or guesswork and be confident that the fitting is properly seated, creating a secure seal. The fitting can be unscrewed and reused.

NEW

Ordering information

CLICK-N-SEAL® FITTINGS FOR 1/16" OD TUBING / 10-32 THREAD				
PART NUMBER	MATERIAL	COLOR	THREAD	QTY
008NT16-KT4L	PEEK™	Natural	10-32	10 pk

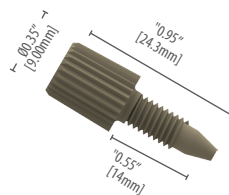

008NT16-KT4L
10-32 cone-tip Click-N-Seal® fitting

The 10-32 flat bottom Click-N-Seal® fitting solution for quick and easy connection of 1/16" tube into a 10-32 flat bottom port

- Pressure rating up to 100 psi
- PEEK™ construction
- Retains 1/16" OD PTFE and other semi-rigid tubing

NEW

Ordering information

CLICK-N-SEAL® FITTINGS FOR 1/16" OD TUBING / 10-32 THREAD				
PART NUMBER	MATERIAL	COLOR	THREAD	QTY
008NF16-KT4L	PEEK™	Natural	10-32	10 pk

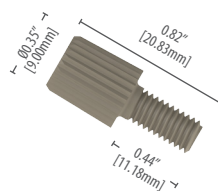

008NF16-KT4L
10-32 flat bottom Click-N-Seal® fitting

Dibafit™ Type P Ferrule System

Chemically inert flangeless fitting with permanently attached PTFE ferrule ideal for repeat connect/disconnect

- Pressure rated up to 1000 psi (69 bar) (see chart below)
- For 1/16", 1/8" or 3/16" OD semi-rigid tubing e.g. PTFE, ETFE, FEP
- For flat-bottom 1/4"-28 UNF, M6 or 5/16"-24 UNF ports
- Use with Omni-Lok™ compact head or Click-N-Seal® self-torquing fittings.

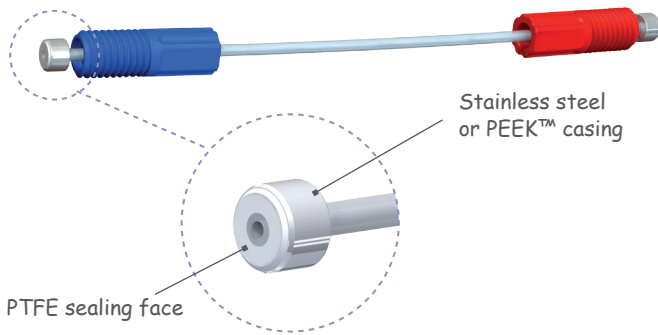

The Dibafit™ Type P fitting system uses a one-piece ferrule which fits permanently onto the outside of semi-rigid tubing. Ferrules have an inner PTFE sealing face ensuring that only PTFE is in the fluid path. The outer casing is stainless steel or PEEK™. The fitting can spin freely, eliminating tubing twist. A recess in the fitting houses the ferrule, allowing maximum thread engagement with the port. This ensures the system stays sealed up to 1000 psi (69 bar) pressure, even in shallow PTFE ports.

Omni-Lok™ Fittings

Omni-Lok™ compact head fittings, in glass-filled polypropylene, are available in a range of different colors for easy line identification. Other options are a longer length fitting for applications where accessibility is an issue (1/8" OD tubing only) and standard head fittings in PEEK™ for higher temperatures.

Click-N-Seal® Fittings

Click-N-Seal® offers a unique system for hand-tight fittings. As the fitting is tightened, the resistance of the cap increases until the correct torque is reached; at which point, the cap clicks. The user is able to hand-tighten the fittings without tools or guesswork and be confident that the fitting is properly seated, creating a secure seal. The fitting can be unscrewed and reused.

Operating Pressures

Stainless Steel Case Ferrules

1/16", 1/8" OD tube in 1/4"-28 or M6 ports	1000 psi (69 bar)
3/16" OD tube in 5/16"-24 ports	200 psi (14 bar)

PEEK™ Case Ferrules

1/16" OD tube in 1/4"-28 or M6 ports	800 psi (56 bar)
1/8" OD tube in 1/4"-28 or M6 ports	600 psi (42 bar)

Ordering information

FERRULES FOR 1/16" OD TUBING

PART NUMBER	DESCRIPTION	QTY
008FT16	PTFE / SS ferrule for 1/4•28 & M6 fittings	10 pk
008FTK16	PTFE / PEEK™ ferrule for 1/4•28 & M6 fittings	10 pk

OMNI-LOK™ FITTINGS FOR 1/16" OD TUBING

PART NUMBER	MATERIAL	COLOR	THREAD	QTY
008NF16-YC5B	PP	Black	1/4•28	10 pk
008NF16-YC5U	PP	Blue	1/4•28	10 pk
008NF16-YC5A	PP	Gray	1/4•28	10 pk
008NF16-YC5G	PP	Green	1/4•28	10 pk
008NF16-YC5N	PP	Orange	1/4•28	10 pk
008NF16-YC5R	PP	Red	1/4•28	10 pk
008NF16-YC5H	PP	White	1/4•28	10 pk
008NF16-YC5Y	PP	Yellow	1/4•28	10 pk
008NF16-YL5B	PP	Black	1/4•28	10 pk
008NF16-YC5M	PP	Mixed	1/4•28	10 pk
008NF16-YC6B	PP	Black	M6	10 pk
002122S	PEEK™	Natural	1/4•28, short	ea

CLICK-N-SEAL® FITTINGS FOR 1/16" OD TUBING

PART NUMBER	MATERIAL	COLOR	THREAD	QTY
008NF16-CS5B	PC	Black	1/4•28	10 pk
008NF16-CS5H	PC	White	1/4•28	10 pk
008NF16-CS5R	PC	Red	1/4•28	10 pk
008NF16-CS6B	PC	Black	M6	10 pk
008NF16-CS6H	PC	White	M6	10 pk
008NF16-CS6R	PC	Red	M6	10 pk

CLICK-N-SEAL® PLUS FITTINGS FOR 1/16" OD TUBING

PART NUMBER	MATERIAL	COLOR	THREAD	QTY
008NF16-AT5H	Acetal	White	1/4•28	10 pk
008NF16-AT6H	Acetal	White	M6	10 pk

CLICK-N-SEAL® ULTRA FITTINGS FOR 1/16" OD TUBING

PART NUMBER	MATERIAL	COLOR	THREAD	QTY
008NF16-KT5L	PEEK™	Natural	1/4•28	10 pk

NOTE :

Assembly of Type P ferrules onto tubing requires the use of simple tooling such as pliers and a knife. See the assembly instructions on our website for full details.

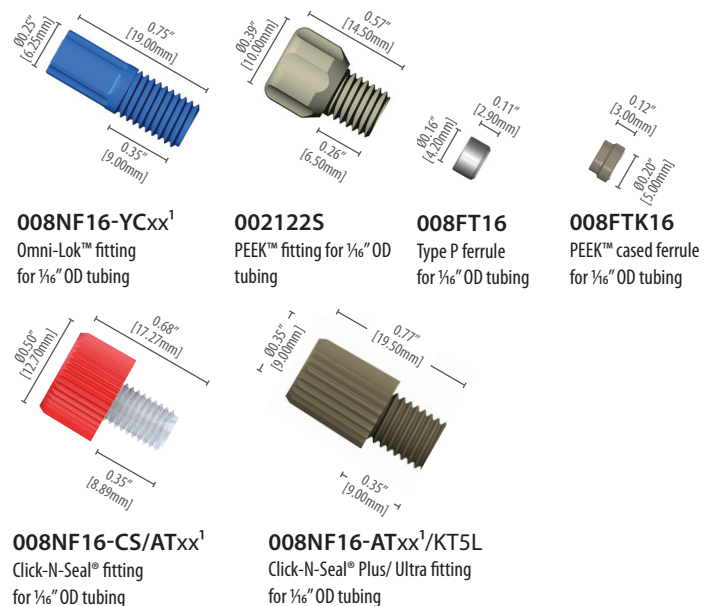

¹The dimensions shown apply to all variants within the product group

Ordering information

FERRULES FOR 1/8" OD TUBING

PART NUMBER	DESCRIPTION	QTY
008FT32	PTFE / SS ferrule for 1/4•28 & M6 fittings	10 pk
008FTK32	PTFE / PEEK™ ferrule for 1/4•28 & M6 fittings	10 pk

OMNI-LOK™ FITTINGS FOR 1/8" OD TUBING

PART NUMBER	MATERIAL	COLOR	THREAD	QTY
008NF32-YC5B	PP	Black	1/4•28	10 pk
008NF32-YC5U	PP	Blue	1/4•28	10 pk
008NF32-YC5A	PP	Gray	1/4•28	10 pk
008NF32-YC5G	PP	Green	1/4•28	10 pk
008NF32-YC5N	PP	Orange	1/4•28	10 pk
008NF32-YC5R	PP	Red	1/4•28	10 pk
008NF32-YC5H	PP	White	1/4•28	10 pk
008NF32-YC5Y	PP	Yellow	1/4•28	10 pk
008NF32-YL5B	PP	Black	1/4•28	10 pk
008NF32-YC5M	PP	Mixed	1/4•28	10 pk
008NF32-YC6B	PP	Black	M6	10 pk
002222S	PEEK™	Natural	1/4•28	ea

CLICK-N-SEAL® FITTINGS FOR 1/8" OD TUBING

PART NUMBER	MATERIAL	COLOR	THREAD	QTY
008NF32-CS5B	PC	Black	1/4•28	10 pk
008NF32-CS5H	PC	White	1/4•28	10 pk
008NF32-CS5R	PC	Red	1/4•28	10 pk
008NF32-CS6B	PC	Black	M6	10 pk
008NF32-CS6H	PC	White	M6	10 pk
008NF32-CS6R	PC	Red	M6	10 pk

CLICK-N-SEAL® PLUS FITTINGS FOR 1/8" OD TUBING

PART NUMBER	MATERIAL	COLOR	THREAD	QTY
008NF32-AT5H	Acetal	White	1/4•28	10 pk
008NF32-AT6H	Acetal	White	M6	10 pk

CLICK-N-SEAL® ULTRA FITTINGS FOR 1/8" OD TUBING

PART NUMBER	MATERIAL	COLOR	THREAD	QTY
008NF32-KT5L	PEEK™	Natural	1/4•28	10 pk

BLANKING PLUG FOR 1/4•28 FLAT-BOTTOM PORTS

PART NUMBER	MATERIAL	COLOR	THREAD	QTY
002320	ETFE	Natural	1/4•28	2 pk

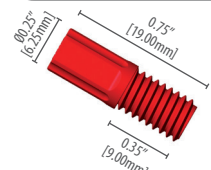

008NF32-YCxx¹
Omni-Lok™ fitting
for 1/8" OD tubing

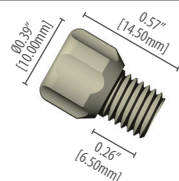

002222S
PEEK™ fitting
for 1/8" OD tubing, 1/4•28

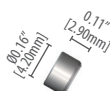

008FT32
Type P ferrule
for 1/8" OD tubing



008FTK32
PEEK™ cased ferrule
for 1/8" OD tubing

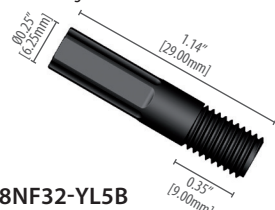

008NF32-YL5B
Long fitting for 1/8" OD tubing
1/4•28, black

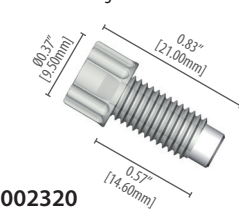

002320
ETFE plug
for 1/4•28 ports

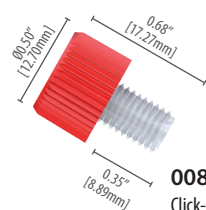

008NF32-Cxx¹
Click-N-Seal® fitting for
1/8" OD tubing

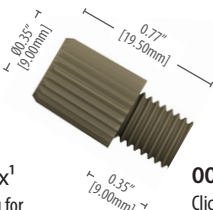

008NF32-ATxx¹/KT5L
Click-N-Seal® Plus / Ultra fitting
for 1/8" OD tubing

Ordering information

FERRULES FOR 3/16" OD TUBING

PART NUMBER	DESCRIPTION	QTY
008FT47	PTFE / SS ferrule for 3/16•24 fittings	10 pk

OMNI-LOK™ FITTINGS FOR 3/16" OD TUBING

PART NUMBER	MATERIAL	COLOR	THREAD	QTY
008NF47-YC7B	PP	Black	3/16•24	10 pk

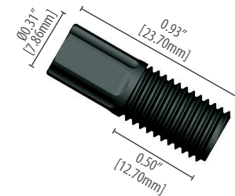

008NF47-YC7B

Fitting for 3/16" OD tubing 3/16•24,
black

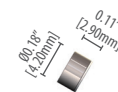

008FT47

Type P ferrule for 3/16" OD tubing
black

FEP Sample Loops & Mixing Coils

FEP sample loops and mixing coils use Click-N-Seal® Ultra 1/4"-28 UNF fittings with Diba flared tubing for a secure and inert connection. Sample loops are 1/16" OD FEP with a variety of tube IDs and volumes. Mixing coils are 1/16" OD x 0.020" ID FEP in a variety of lengths. Loops and coils with ferrule connection systems are also available as a special request item - contact the factory for a quote.

Ordering information

SAMPLE LOOPS

PART NUMBER	OD	ID	VOLUME (UL)	QTY
008L25F16-KT5L	1.6mm (1/16")	0.5mm (.020")	25	ea
008L50F16-KT5L	1.6mm (1/16")	0.8mm (.031")	50	ea
008L100F16-KT5L	1.6mm (1/16")	0.8mm (.031")	100	ea
008L200F16-KT5L	1.6mm (1/16")	0.8mm (.031")	200	ea
008L300F16-KT5L	1.6mm (1/16")	0.8mm (.031")	300	ea
008L400F16-KT5L	1.6mm (1/16")	1.0mm (.039")	400	ea
008L500F16-KT5L	1.6mm (1/16")	1.0mm (.039")	500	ea
008L1000F16-KT5L	1.6mm (1/16")	1.0mm (.039")	1000	ea
008L1500F16-KT5L	1.6mm (1/16")	1.0mm (.039")	1500	ea
008L2000F16-KT5L	1.6mm (1/16")	1.0mm (.039")	2000	ea
008L2500F16-KT5L	1.6mm (1/16")	1.0mm (.039")	2500	ea

MIXING COILS

PART NUMBER	OD	ID	LENGTH (MM)	QTY
008C20F16-KT5L	1.6mm (1/16")	0.5mm (.020")	20	ea
008C40F16-KT5L	1.6mm (1/16")	0.5mm (.020")	40	ea
008C80F16-KT5L	1.6mm (1/16")	0.5mm (.020")	80	ea
008C120F16-KT5L	1.6mm (1/16")	0.5mm (.020")	120	ea

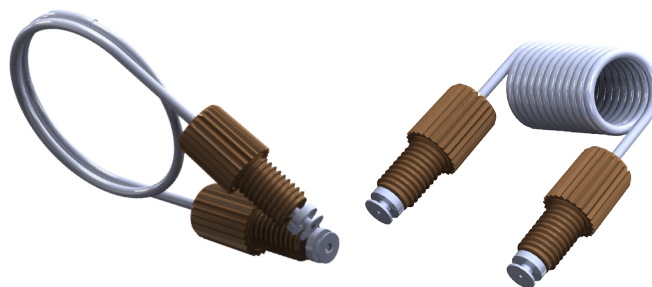

Dibaft™ Type S Ferrule System

Chemically inert with permanently attached PEEK™ or ETFE ferrules, ideal for repeated connect/disconnect

- Pressure rated up to 500 psi (34 bar) or more (see chart below)
- For 1/16", 1/8" or 3/16" OD semi-rigid tubing e.g. PTFE, ETFE, FEP
- For flat-bottom 1/4"-28 UNF, M6 or 5/16"-24 UNF ports
- *NEW!* For flat-bottom or taper 6-40 ports
- PEEK™ ferrules can be used with rigid tubing, e.g. PEEK™

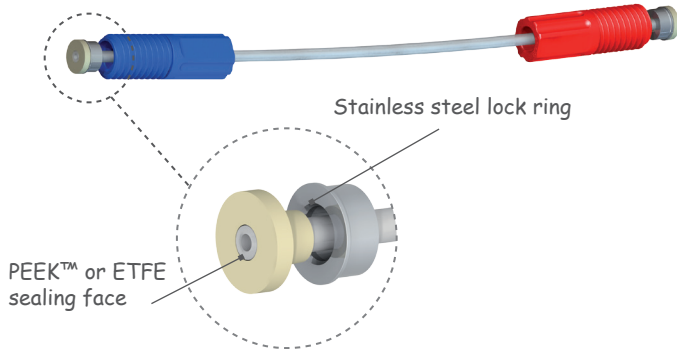

The Dibaft™ Type S fitting system uses a two-piece ferrule which fits permanently to the outside of the tubing. Two-part ferrules consist of an inner PEEK™ or ETFE sealing surface surrounded by a stainless steel lock ring with only the inner portion in the fluid path. The fitting can spin freely, eliminating tubing twist. A recess in the fitting houses the ferrule, allowing maximum thread engagement with the port. This ensures the system stays sealed up to 500 psi (34 bar) pressure, even in shallow PTFE ports.

Omni-Lok™ Fittings

See description on page 6. The Type S PEEK™ ferrule can be used with rigid PEEK™ tubing and a PEEK™ fitting to create a robust, high temperature assembly.

Click-N-Seal® Fittings

See description on page 6.

FERRULES FOR 1/16" OD TUBING / 6-40 THREAD				
PART NUMBER	DESCRIPTION	QTY		
008FK16-03C9L	PEEK™ ferrule; taper port, 0.3mm through hole	10 pk		
008FK16-05C9L	PEEK™ ferrule; taper port, 0.5mm through hole	10 pk		
008FK16-08C9L	PEEK™ ferrule; taper port, 0.8mm through hole	10 pk		
008FK16-F9L	PEEK™ ferrule; flat port, and SS lock ring	10 pk		
OMNI-LOK™ FITTINGS FOR 1/16" OD TUBING / 6-40 THREAD				
PART NUMBER	MATERIAL	COLOR	THREAD	QTY
008NF16-KC9L	PEEK™	Natural	6-40	10 pk
CLICK-N-SEAL® MICRO FOR 1/16" OD TUBING / 6-40 THREAD				
PART NUMBER	MATERIAL	COLOR	THREAD	QTY
008NF16-KT9L	PEEK™	Natural	6-40	10 pk
008NF16-KT9B	PEEK™	Black	6-40	10 pk
008NF16-KT9R	PEEK™	Red	6-40	10 pk

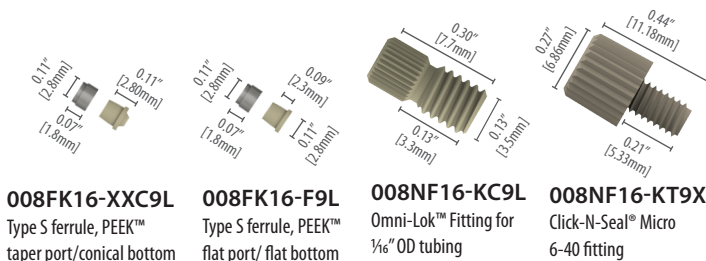

Ordering information

FERRULES FOR 1/16" OD TUBING				
PART NUMBER	DESCRIPTION	QTY		
008FK16	PEEK™ ferrule and SS lock ring	10 pk		
008FZ16	ETFE ferrule and SS lock ring	10 pk		
008FK16-C1	PEEK™ ferrule; taper port and SS lock ring	10 pk		
OMNI-LOK™ FITTINGS FOR 1/16" OD TUBING				
PART NUMBER	MATERIAL	COLOR	THREAD	QTY
008NF16-YC5B	PP	Black	1/4-28	10 pk
008NF16-YC5U	PP	Blue	1/4-28	10 pk
008NF16-YC5A	PP	Gray	1/4-28	10 pk
008NF16-YC5G	PP	Green	1/4-28	10 pk
008NF16-YC5N	PP	Orange	1/4-28	10 pk
008NF16-YC5R	PP	Red	1/4-28	10 pk
008NF16-YC5H	PP	White	1/4-28	10 pk
008NF16-YC5Y	PP	Yellow	1/4-28	10 pk
008NF16-YL5B	PP	Black	1/4-28	10 pk
008NF16-YC5M	PP	Mixed	1/4-28	10 pk
008NF16-YC6B	PP	Black	M6	10 pk
002122S	PEEK™	Natural	1/4-28, short	ea
CLICK-N-SEAL® FITTINGS FOR 1/16" OD TUBING				
PART NUMBER	MATERIAL	COLOR	THREAD	QTY
008NF16-CS5B	PC	Black	1/4-28	10 pk
008NF16-CS5H	PC	White	1/4-28	10 pk
008NF16-CS5R	PC	Red	1/4-28	10 pk
008NF16-CS6B	PC	Black	M6	10 pk
008NF16-CS6H	PC	White	M6	10 pk
008NF16-CS6R	PC	Red	M6	10 pk
CLICK-N-SEAL® PLUS FITTINGS FOR 1/16" OD TUBING				
PART NUMBER	MATERIAL	COLOR	THREAD	QTY
008NF16-AT5H	Acetal	White	1/4-28	10 pk
008NF16-AT6H	Acetal	White	M6	10 pk
CLICK-N-SEAL® ULTRA FITTINGS FOR 1/16" OD TUBING				
PART NUMBER	MATERIAL	COLOR	THREAD	QTY
008NF16-KT4L	PEEK™	Natural	10-32	10 pk
008NF16-KT5L	PEEK™	Natural	1/4-28	10 pk

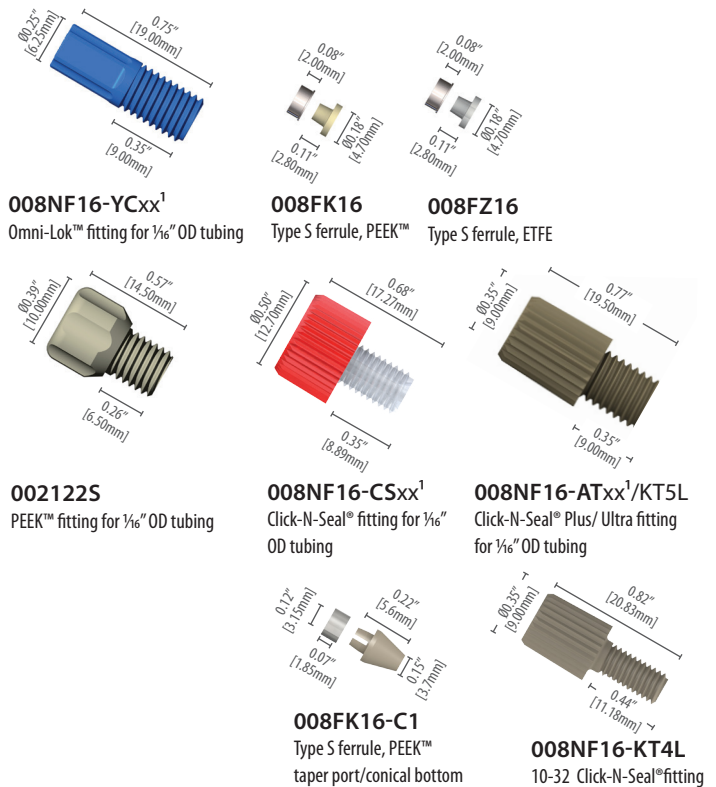

Operating Pressures

1/16", 1/8" OD tube in 1/4"-28 or M6 ports	500 psi (34 bar)
3/16" OD tube in 5/16"-24 ports	200 psi (14 bar)
1/16" OD tube in 10-32 ports	2500 psi (172 bar)

Ordering information

FERRULES FOR 1/8" OD TUBING				
PART NUMBER	DESCRIPTION			QTY
008FK32	PEEK™ ferrule and SS lock ring			10 pk
008FZ32	ETFE ferrule and SS lock ring			10 pk
OMNI-LOK™ FITTINGS FOR 1/8" OD TUBING				
PART NUMBER	MATERIAL	COLOR	THREAD	QTY
008NF32-YC5B	PP	Black	1/4-28	10 pk
008NF32-YC5U	PP	Blue	1/4-28	10 pk
008NF32-YC5A	PP	Gray	1/4-28	10 pk
008NF32-YC5G	PP	Green	1/4-28	10 pk
008NF32-YC5N	PP	Orange	1/4-28	10 pk
008NF32-YC5R	PP	Red	1/4-28	10 pk
008NF32-YC5H	PP	White	1/4-28	10 pk
008NF32-YC5Y	PP	Yellow	1/4-28	10 pk
008NF32-YL5B	PP	Black	1/4-28	10 pk
008NF32-YC5M	PP	Mixed	1/4-28	10 pk
008NF32-YC6B	PP	Black	M6	10 pk
002222S	PEEK™	Natural	1/4-28	ea
CLICK-N-SEAL® FITTINGS FOR 1/8" OD TUBING				
PART NUMBER	MATERIAL	COLOR	THREAD	QTY
008NF32-CS5B	PC	Black	1/4-28	10 pk
008NF32-CS5H	PC	White	1/4-28	10 pk
008NF32-CS5R	PC	Red	1/4-28	10 pk
008NF32-CS6B	PC	Black	M6	10 pk
008NF32-CS6H	PC	White	M6	10 pk
008NF32-CS6R	PC	Red	M6	10 pk
CLICK-N-SEAL® PLUS FITTINGS FOR 1/8" OD TUBING				
PART NUMBER	MATERIAL	COLOR	THREAD	QTY
008NF32-AT5H	Acetal	White	1/4-28	10 pk
008NF32-AT6H	Acetal	White	M6	10 pk
CLICK-N-SEAL® ULTRA FITTINGS FOR 1/8" OD TUBING				
PART NUMBER	MATERIAL	COLOR	THREAD	QTY
008NF32-KT5L	PEEK™	Natural	1/4-28	10 pk

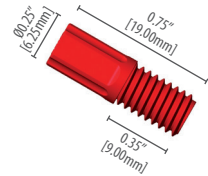

008NF32-YCxx¹
Fitting for 1/8" OD tubing

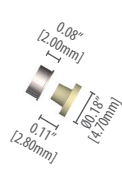

008FK32
Type S ferrule, PEEK™

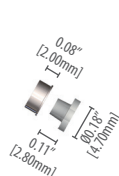

008FZ32
Type S ferrule, ETFE

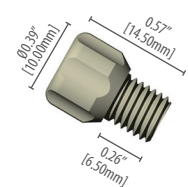

002222S
PEEK™ fitting for 1/8" OD tubing

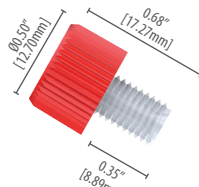

008NF32-CSxx¹
Click-N-Seal® fitting for 1/8" OD tubing

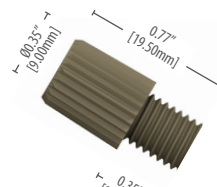

008NF32-ATxx¹/KT5L
Click-N-Seal® Plus/ Ultra fitting for 1/8" OD tubing

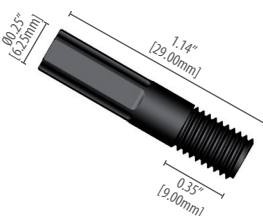

008NF32-YL5B
Long fitting for 1/8" OD tubing

¹The dimensions shown apply to all variants within the product group

Ordering information

FERRULES FOR 3/16" OD TUBING				
PART NUMBER	DESCRIPTION			QTY
008FK47	One piece PEEK™ ferrule for 5/16-24 fittings			10 pk
008FZ47	One piece ETFE ferrule for 5/16-24 fittings			10 pk
OMNI-LOK™ FITTINGS FOR 3/16" OD TUBING				
PART NUMBER	MATERIAL	COLOR	THREAD	QTY
008NF47-YC7B	PP	Black	5/16-24	10 pk

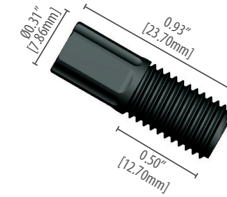

008NF47-YC7B
Fitting for 3/16" OD tubing, 5/16-24

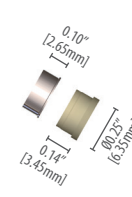

008FK47
Two-part ferrule, PEEK™

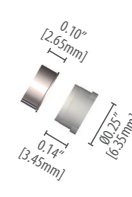

008FZ47
Two-part ferrule, ETFE

Omni-Lok™ Type S Assembly Tool

Omni-Lok™ Type S ferrule assembly requires the Omni-Lok™ Type S Assembly Tool, which press fits the lock ring onto the ferrule and assembles both parts onto the tube end in one simple operation. Full instructions are provided with the tool and on our website (www.dibaind.com).

Ordering information

OMNI-LOK™ TYPE S ASSEMBLY TOOL		
PART NUMBER	DESCRIPTION	QTY
008AT	Omni-Lok™ Type S Assembly Tool	ea
008AT-T	Omni-Lok™ Type S Assembly Tool for tapered ferrules	ea

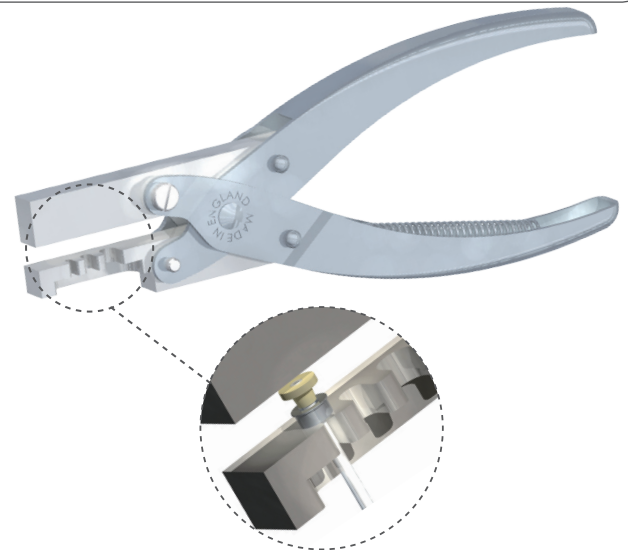

Technical note

Problems with shallow or PTFE ports?

Some shallow ports, especially those found in solenoid valves, may offer limited thread engagement for most standard fittings. Ports machined from PTFE can also be slippery and difficult to seal, with fittings becoming loose and "backing out". With glass-filled polypropylene and a recessed ferrule, Omni-Lok™ fittings are specifically designed for use in shallow and PTFE ports to ensure maximum security and a leak-free seal.

Dibafit™ Inverted Cone System

Removable and reusable system for quick and convenient low-pressure connections

- Pressure rated up to 250 psi (17 bar) (see chart below)
- For 1/16", 1/8" or 3/16" OD and metric sizes 2.0, 2.5 or 3.0mm OD semi-rigid tubing e.g. PTFE, ETFE, FEP
- For flat-bottom 1/4"-28 UNF, M6 or 5/16"-24 UNF ports
- Use with Omni-Lok™ compact head or Click-N-Seal® self-torquing fittings.

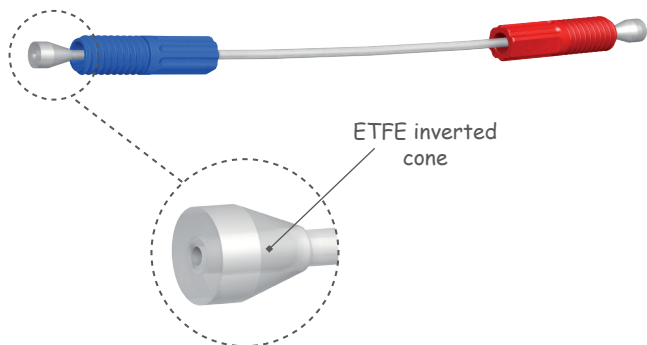

Omni-Lok™ inverted cones provide a simple, easy to use low-pressure connection. Only the ETFE cone is in the fluid path. No tools are required to assemble a flangeless fitting quickly and economically - just slip the fitting and the ETFE cone over the tubing and screw into the port. None of the parts are permanently attached to the tubing, so both fittings and inverted cones can easily be removed and re-used. A recess in the fitting houses the inverted cone, allowing maximum thread engagement with the port ensuring the system stays sealed up to 250 psi (17 bar) pressure even in shallow PTFE ports.

Omni-Lok™ Fittings

Omni-Lok™ compact head fittings, in glass-filled polypropylene, are available in a range of different colors for easy line identification. Other options are a longer length fitting for applications where accessibility is an issue and standard head fittings in PEEK™ for higher temperatures.

Click-N-Seal® Fittings

Click-N-Seal® offers a unique system for hand-tight fittings. As the fitting is tightened, the resistance of the cap increases until the correct torque is reached; at which point, the cap clicks. The user is able to hand-tighten the fittings without tools or guesswork and be confident that the fitting is properly seated, creating a secure seal. The fitting can be unscrewed and reused.

Operating Pressures

1/16", 1/8" OD tube in 1/4"-28 or M6 ports	250 psi (17 bar)
3/16" OD tube in 5/16"-24 ports	200 psi (14 bar)

Ordering information

INVERTED CONES FOR 1/16" OD TUBING

PART NUMBER	DESCRIPTION	QTY
008CZ16	ETFE inverted cone	10 pk

FITTINGS FOR 1/16" OD TUBING

PART NUMBER	MATERIAL	COLOR	THREAD	QTY
008NC16-YC5U	PP	Blue	1/4-28	10 pk
008NC16-YC5G	PP	Green	1/4-28	10 pk
008NC16-YC6U	PP	Blue	M6	10 pk
008NC16-YA5U	PP	Blue	1/4-28	10 pk
002144	PEEK™	Natural	1/4-28	10 pk
002144S	PEEK™	Natural	1/4-28	10 pk
002145	PEEK™	Natural	1/4-28	10 pk

CLICK-N-SEAL® FITTINGS FOR 1/16" OD TUBING

PART NUMBER	MATERIAL	COLOR	THREAD	QTY
008NC16-CS5B	PC	Black	1/4-28	10 pk
008NC16-CS5H	PC	White	1/4-28	10 pk
008NC16-CS5R	PC	Red	1/4-28	10 pk
008NC16-CS6B	PC	Black	M6	10 pk
008NC16-CS6H	PC	White	M6	10 pk
008NC16-CS6R	PC	Red	M6	10 pk

CLICK-N-SEAL® PLUS FITTINGS FOR 1/16" OD TUBING

PART NUMBER	MATERIAL	COLOR	THREAD	QTY
008NC16-AT5H	Acetal	White	1/4-28	10 pk
008NC16-AT6H	Acetal	White	M6	10 pk

CLICK-N-SEAL® ULTRA FITTINGS FOR 1/16" OD TUBING

PART NUMBER	MATERIAL	COLOR	THREAD	QTY
008NC16-KT5L	PEEK™	Natural	1/4-28	10 pk

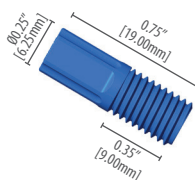

008NC16-YCxx¹
Fitting for 1/16" OD tubing

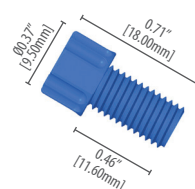

008NC16-YA5U
Fitting for 1/16" OD tubing

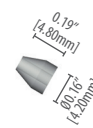

008CZ16
Omni-Lok™ inverted cone
for 1/16" OD tube

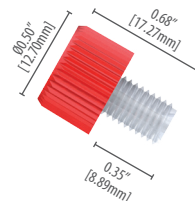

008NC16-CSxx¹
Click-N-Seal® Fitting
for 1/16" OD tubing

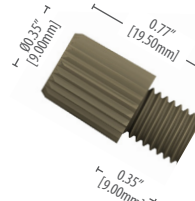

008NC16-ATxx¹/KT5L
Click-N-Seal® Plus/ Ultra Fitting
for 1/16" OD tubing

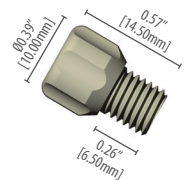

002144S
PEEK™ short thread fitting for
1/16" OD tubing, 1/4-28

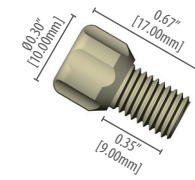

002144
PEEK™ standard head fitting
for 1/16" OD tubing, 1/4-28

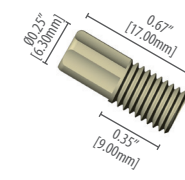

002145
PEEK™ compact head fitting
for 1/16" OD tubing, 1/4-28

Ordering information

INVERTED CONES FOR 2.0, 2.5, 3.0 & 3.2MM (1/8") OD TUBING			
PART NUMBER	MATERIAL	TUBE SIZE	QTY
008CZ19	ETFE	1.8 - 2.0mm	10 pk
008CZ25	ETFE	2.5mm	10 pk
008CZ30	ETFE	3.0mm	10 pk
008CZ32	ETFE	1/8" (3.2mm)	10 pk
001545	ETFE	1/8" (3.2mm)	10 pk

All of the cones listed above are compatible with any of the fittings also listed.

FITTINGS FOR 2.0, 2.5, 3.0 & 3.2MM (1/8") OD TUBING				
PART NUMBER	MATERIAL	COLOR	THREAD	QTY
008NC32-YC5U	PP	Blue	1/4-28	10 pk
008NC32-YC5G	PP	Green	1/4-28	10 pk
008NC32-YC5N	PP	Orange	1/4-28	10 pk
008NC32-YC5R	PP	Red	1/4-28	10 pk
008NC32-YC5Y	PP	Yellow	1/4-28	10 pk
008NC32-YA5U	PP	Blue	1/4-28, std	10 pk
008NC32-YC6U	PP	Blue	M6	10 pk
002244	PEEK™	Natural	1/4-28	10 pk
002244S	PEEK™	Natural	1/4-28, short	10 pk
002245	PEEK™	Natural	1/4-28	10 pk

CLICK-N-SEAL® FITTINGS FOR 1/8" OD TUBING				
PART NUMBER	MATERIAL	COLOR	THREAD	QTY
008NC32-CS5B	PC	Black	1/4-28	10 pk
008NC32-CS5H	PC	White	1/4-28	10 pk
008NC32-CS5R	PC	Red	1/4-28	10 pk
008NC32-CS6B	PC	Black	M6	10 pk
008NC32-CS6H	PC	White	M6	10 pk
008NC32-CS6R	PC	Red	M6	10 pk

CLICK-N-SEAL® PLUS FITTINGS FOR 1/8" OD TUBING				
PART NUMBER	MATERIAL	COLOR	THREAD	QTY
008NC32-AT5H	Acetal	White	1/4-28	10 pk
008NC32-AT6H	Acetal	White	M6	10 pk

CLICK-N-SEAL® ULTRA FITTINGS FOR 1/8" OD TUBING				
PART NUMBER	MATERIAL	COLOR	THREAD	QTY
008NC32-KT5L	PEEK	Natural	1/4-28	10 pk

Ordering information

INVERTED CONES FOR 3/16" OD TUBING		
PART NUMBER	DESCRIPTION	QTY
008CZ47	ETFE inverted cone	10 pk

PEEK™ FITTINGS FOR 3/16" OD TUBING				
PART NUMBER	MATERIAL	COLOR	THREAD	QTY
008NC47-YC7U	PP	Blue	5/16-24	10 pk

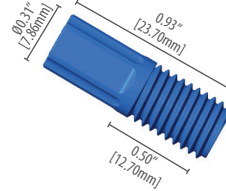

008NC47-YC7U
Omni-Lok™ Fitting
for 3/16" OD tubing, 5/16-24

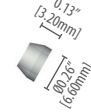

008CZ47
Omni-Lok™ inverted cone
for 3/16" OD tubing

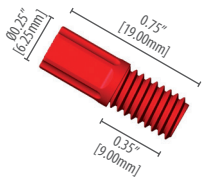

008NC32-YCxx¹
Fitting for 2.0-3.2mm OD tubing



008CZxx
Omni-Lok™ inverted cones
for 2.0-3.2mm OD tubing

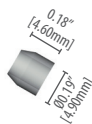

001545
ETFE inverted cone
for 2.0-3.2mm OD tubing

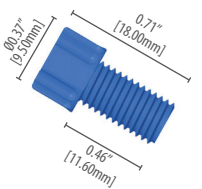

008NC32-YA5U
Standard head fitting
for 2.0-3.2mm OD tubing

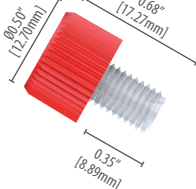

008NC32-CSxx¹
Click-N-Seal® Fitting for
2.0-3.2mm OD tubing

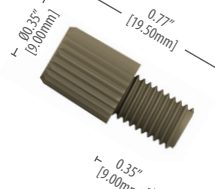

008NC32-ATxx¹/KT5L
Click-N-Seal® Plus/ Ultra Fitting
for 2.0-3.2mm OD tubing

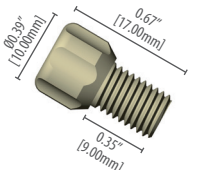

002244
Standard PEEK™ fitting for 2.0-3.2mm OD tubing

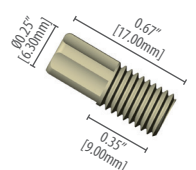

002245
Compact PEEK™ fitting for
2.0-3.2mm OD tubing

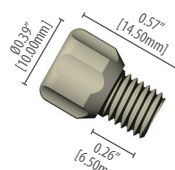

002244S
Shorter thread PEEK™ fitting
for 2.0-3.2mm OD tubing

¹The dimensions shown apply to all variants within the product group

Dibaft™ Gripper Fittings

Chemically inert flangeless fitting with permanently attached PTFE ferrule ideal for repeat connect/disconnect

- Pressure rated up to 1000 psi (69 bar) (see chart below)
- For 1/16" or 1/8" OD semi-rigid tubing
- For 1/4"-28 UNF or M6 flat-bottom ports

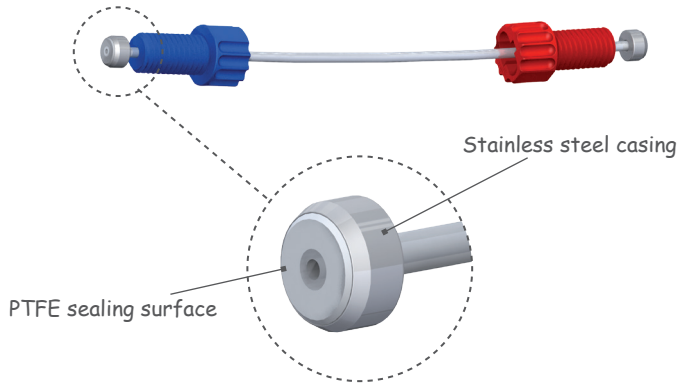

The Dibaft™ Gripper fitting system uses a one-piece ferrule which fits permanently onto the outside of semi-rigid tubing. Ferrules have an inner PTFE sealing face ensuring that only PTFE is in the fluid path. The outer casing is stainless steel or PEEK™. The fitting can spin freely, eliminating tubing twist and allowing easy repeat connect/disconnect. The system is pressure rated up to 1000 psi (69 bar).

A range of different colored polypropylene fittings are available to connect 1/16" or 1/8" OD tubing into 1/4"-28 UNF flat-bottom ports. Mixed color packs include all 10 colors for easy line identification. PEEK™ fittings for use in higher temperatures are available in standard or compact head styles and with 1/4"-28 UNF, M6 or 10-32 threads.

An ETFE blanking plug with a PTFE sealing face is available to seal unused ports. These blanking plugs can be used in any flat-bottom 1/4"-28 UNF port.

In-line Connectors

Compact in-line connectors using the Dibaft™ Gripper are ideal when space is limited. Tubing line 1 is passed through the connector and secured using a Gripper ferrule. The 1/4"-28 UNF female port then accepts a standard threaded fitting from a second fluid line.

Ordering information

IN-LINE CONNECTORS					
PART NUMBER	MATERIAL	COLOR	THREAD S	BORE	QTY
002333	PEEK™	Natural	1/4"-28 F	1/16"	ea
002334	PEEK™	Natural	1/4"-28 F	1/8"	ea
002CN2-16A	Acetal	White	1/4"-28 F	1/16"	10
002CN2-32A	Acetal	White	1/4"-28 F	1/8"	10

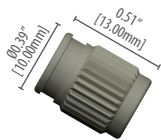

002333 / 002334
PEEK™ in-line connector for
1/4"-28 F threads

Ordering information

GRIPPERS FOR 1/16" OD TUBING				
PART NUMBER	DESCRIPTION	QTY		
002310	PTFE / SS ferrule for 1/4"-28 fittings	10 pk		
002313	PTFE / SS ferrule for M6 fitting fittings	10 pk		
008FTK16	PTFE / PEEK™ ferrule for 1/4"-28 & M6 fittings	10 pk		
FITTINGS FOR 1/16" OD TUBING				
PART NUMBER	MATERIAL	COLOR	THREAD	QTY
002100	PP	Black	1/4"-28	10 pk
002101	PP	Brown	1/4"-28	10 pk
002102	PP	Red	1/4"-28	10 pk
002103	PP	Orange	1/4"-28	10 pk
002104	PP	Yellow	1/4"-28	10 pk
002105	PP	Green	1/4"-28	10 pk
002106	PP	Blue	1/4"-28	10 pk
002107	PP	Violet	1/4"-28	10 pk
002108	PP	Gray	1/4"-28	10 pk
002109	PP	White	1/4"-28	10 pk
002110	PP	Mixed	1/4"-28	10 pk
002130	ETFE	Natural	1/4"-28	10 pk
002119	PEEK™	Natural	1/4"-28	10 pk
002122	PEEK™	Natural	1/4"-28	10 pk
002135	PEEK™	Natural	M6	10 pk
CLICK-N-SEAL® ULTRA FITTINGS FOR 1/16" OD TUBING				
PART NUMBER	MATERIAL	COLOR	THREAD	QTY
008NG16-KT5L	PEEK™	Natural	1/4"-28	10 pk
008NG16-KT4L	PEEK™	Natural	10-32	10 pk

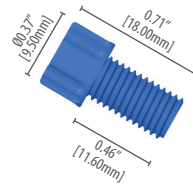

002100 Series
Fitting for 1/16" OD tubing

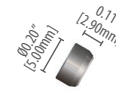

002310
Gripper ferrule
for 1/16" OD tubing
1/4"-28 fitting

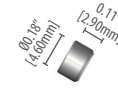

002313
Gripper ferrule
for 1/16" OD tubing
M6 fitting

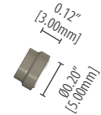

008FTK16
PEEK™ cased ferrule
for 1/16" OD tubing

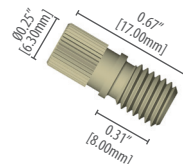

002119
Compact PEEK™ fitting
for 1/16" OD tubing, 1/4"-28

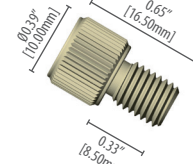

002122
PEEK™ fitting
for 1/16" OD tubing, 1/4"-28

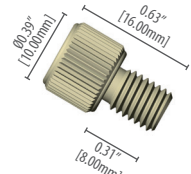

002135
PEEK™ fitting
for 1/16" OD tubing, M6

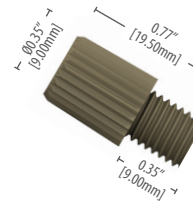

008NG16-KTXL
Click-N-Seal® Plus/ Ultra fitting
for 1/16" OD tubing

Operating Pressures

Stainless Steel Case Ferrules

1/16", 1/8" OD tube in 1/4"-28 or M6 ports	1000 psi (69 bar)
3/16" OD tube in 5/16"-24 ports	200 psi (14 bar)

PEEK™ Case Ferrules

1/16" OD tube in 1/4"-28 or M6 ports	800 psi (56 bar)
1/8" OD tube in 1/4"-28 or M6 ports	600 psi (42 bar)

Ordering information

GRIPPERS FOR 1/8" OD TUBING

PART NUMBER	DESCRIPTION	QTY
002312	PTFE / SS ferrule for 1/4-28 fittings	10 pk
002314	PTFE / SS ferrule for M6 fittings	10 pk
008FTK32	PTFE / PEEK™ ferrule for 1/4-28 & M6 fittings	10 pk

FITTINGS FOR 1/8" OD TUBING

PART NUMBER	MATERIAL	COLOR	THREAD	QTY
002200	PP	Black	1/4-28	10 pk
002201	PP	Brown	1/4-28	10 pk
002202	PP	Red	1/4-28	10 pk
002203	PP	Orange	1/4-28	10 pk
002204	PP	Yellow	1/4-28	10 pk
002205	PP	Green	1/4-28	10 pk
002206	PP	Blue	1/4-28	10 pk
002207	PP	Violet	1/4-28	10 pk
002208	PP	Gray	1/4-28	10 pk
002209	PP	White	1/4-28	10 pk
002210	PP	Mixed	1/4-28	10 pk
002230	ETFE	Natural	1/4-28	10 pk
002219	PEEK™	Natural	1/4-28	ea
002222	PEEK™	Natural	1/4-28	ea
002235	PEEK™	Natural	M6	ea

BLANKING PLUG FOR 1/4-28 FLAT-BOTTOM PORTS

PART NUMBER	MATERIAL	COLOR	THREAD	QTY
002320	ETFE	Natural	1/4-28	2pk

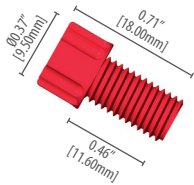

002200 Series
Fitting for 1/8" OD tubing

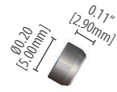

002312
Gripper ferrule
for 1/8" OD tubing
1/4-28 fitting

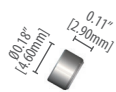

002314
Gripper ferrule
for 1/8" OD tubing
M6 fitting



008FTK32
PEEK™ cased ferrule
for 1/8" OD tubing

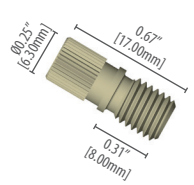

002219
Compact PEEK™ fitting
for 1/8" OD tubing, 1/4-28

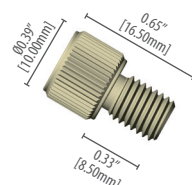

002222
PEEK™ fitting
for 1/8" OD tubing, 1/4-28

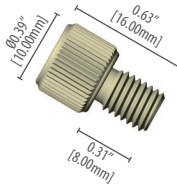

002235
PEEK™ fitting
for 1/8" OD tubing, M6

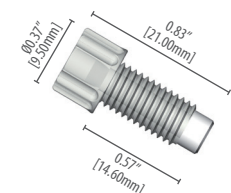

002320
ETFE plug for 1/4-28 ports

NOTE :

Assembly of Dibafit™ Gripper ferrules onto tubing requires the use of simple tooling such as pliers and a knife. See the assembly instructions on our website for full details.

Adaptors, Couplings & Connectors

Dibafit™ threaded adaptors and unions enable you to connect fitting lines and convert thread sizes quickly and easily.

Ordering information

TWO-WAY ADAPTORS

PART NUMBER	MATERIAL	COLOR	THREAD 1	THREAD 2	BORE	QTY
002306	PEEK™	Natural	1/4-28 F	10-32 F	1.5mm	ea
002352	PEEK™	Natural	1/4-28 F	M6 M	1.5mm	ea

UNIONS

PART NUMBER	MATERIAL	COLOR	THREAD 1	THREAD 2	BORE	QTY
002301	PP	White	1/4-28 F	1/4-28 F	1.5mm	10 pk
002302	ETFE	Natural	1/4-28 F	1/4-28 F	1.5mm	10 pk
002307	PEEK™	Natural	1/4-28 F	1/4-28 F	1.5mm	ea
002UN2-A	Acetal	White	1/4-28 F	1/4-28 F	1/16"	ea
002UT2-08K	PEEK™	Natural	1/4-28 F	1/4-28 F	1/32"	ea

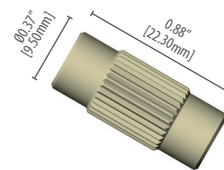

002306
PEEK™ adaptor, 1/4-28 to 10-32

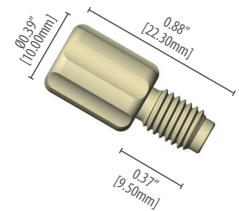

002352
PEEK™ adaptor, 1/4-28 F to M6 M

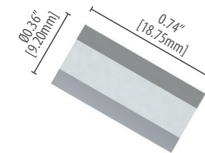

002301 / 002302
PP / ETFE coupling, 1/4-28

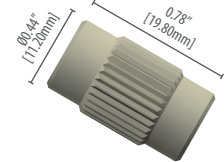

002307
PEEK™ coupling, 1/4-28 M

Mountable Block Connectors

The 3-way and 4-way block connectors have an internal bore of 1.5mm. They are mountable and when used with Omnifit Gripper fittings or Omni-Lok™ Type P or S fittings, provide an inert fluid path with zero dead volume.

Ordering information

3-WAY & 4-WAY BLOCK CONNECTORS

PART NUMBER	MATERIAL	COLOR	THREAD S	CONFIGURATION	QTY
001057	PEEK™	Natural	1/4-28 F	3-way	ea
001058	PEEK™	Natural	1/4-28 F	4-way	ea

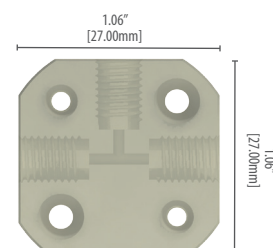

001057
3-way PEEK™ block connector
for 1/4-28 F threads

Barbed Adaptors

Thread to barb adaptors to connect softwall tubing to threaded ports or to semi-rigid tubing

Dibafit™ barbed adaptors are designed for use with soft-wall tubing. Machined from chemically resistant PEEK™ or acetal they have a superior barb with a crisp edge that retains soft wall tubing more securely than molded adaptors. A tight, leak-free connection can be ensured by matching the ID of your tubing to the barb size of the adaptor. If there is not an exact match, always choose the barb size that is just larger than your tubing ID.

To connect softwall tubing into any female 1/4"-28 UNF port, use a male 1/4"-28 UNF to barb adaptor. The male thread screws into the port and tubing can then be pushed over the barb. To connect softwall tubing to any male 1/4"-28 UNF thread, use a female 1/4"-28 UNF to barb adaptor. The barb is inserted into the softwall tubing and the female 1/4"-28 UNF port is available to receive any 1/4"-28 UNF threaded fitting.

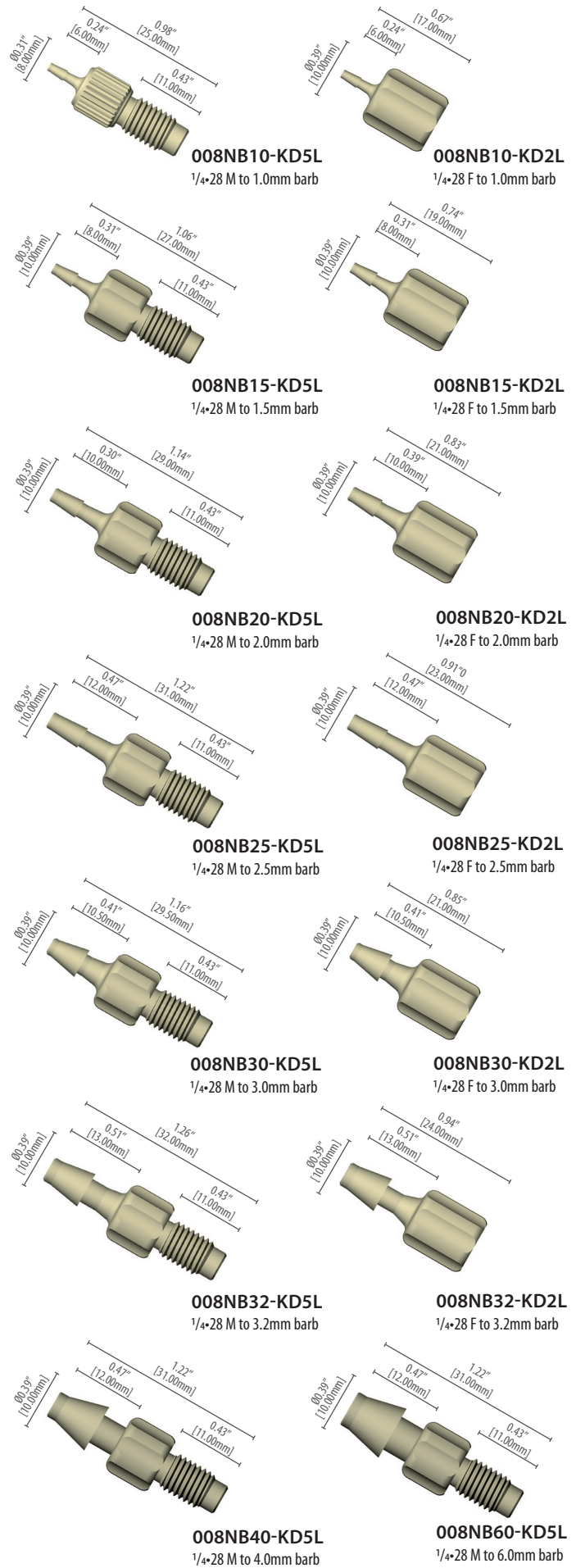

Ordering information

MALE 1/4"-28 UNF TO BARB ADAPTOR					
PART NUMBER	MATERIAL	COLOR	THREAD	TUBE ID	QTY
008NB10-KD5L	PEEK™	Natural	1/4-28 M	1.0mm	5 pk
008NB15-KD5L	PEEK™	Natural	1/4-28 M	1.5mm	5 pk
008NB20-KD5L	PEEK™	Natural	1/4-28 M	2.0mm	5 pk
008NB25-KD5L	PEEK™	Natural	1/4-28 M	2.5mm	5 pk
008NB30-KD5L	PEEK™	Natural	1/4-28 M	3.0mm	5 pk
008NB32-KD5L	PEEK™	Natural	1/4-28 M	3.2mm	5 pk
008NB40-KD5L	PEEK™	Natural	1/4-28 M	4.0mm	5 pk
008NB60-KD5L	PEEK™	Natural	1/4-28 M	6.0mm	5 pk
008NB10-AD5B	Acetal	Natural	1/4-28 M	1.0mm	5 pk
008NB15-AD5B	Acetal	Natural	1/4-28 M	1.5mm	5 pk
008NB20-AD5B	Acetal	Natural	1/4-28 M	2.0mm	5 pk
008NB25-AD5B	Acetal	Natural	1/4-28 M	2.5mm	5 pk
008NB30-AD5B	Acetal	Natural	1/4-28 M	3.0mm	5 pk
008NB32-AD5B	Acetal	Natural	1/4-28 M	3.2mm	5 pk
008NB40-AD5B	Acetal	Natural	1/4-28 M	4.0mm	5 pk
008NB60-AD5B	Acetal	Natural	1/4-28 M	6.0mm	5 pk
008NB80-AD5B	Acetal	Natural	1/4-28 M	8.0mm	5 pk
FEMALE 1/4"-28 UNF TO BARB ADAPTOR					
PART NUMBER	MATERIAL	COLOR	THREAD	TUBE ID	QTY
008NB10-KD2L	PEEK™	Natural	1/4-28 F	1.0mm	5 pk
008NB15-KD2L	PEEK™	Natural	1/4-28 F	1.5mm	5 pk
008NB20-KD2L	PEEK™	Natural	1/4-28 F	2.0mm	5 pk
008NB25-KD2L	PEEK™	Natural	1/4-28 F	2.5mm	5 pk
008NB30-KD2L	PEEK™	Natural	1/4-28 F	3.0mm	5 pk
008NB32-KD2L	PEEK™	Natural	1/4-28 F	3.2mm	5 pk
008NB10-AD2B	Acetal	Natural	1/4-28 F	1.0mm	5 pk
008NB15-AD2B	Acetal	Natural	1/4-28 F	1.5mm	5 pk
008NB20-AD2B	Acetal	Natural	1/4-28 F	2.0mm	5 pk
008NB25-AD2B	Acetal	Natural	1/4-28 F	2.5mm	5 pk
008NB30-AD2B	Acetal	Natural	1/4-28 F	3.0mm	5 pk
008NB32-AD2B	Acetal	Natural	1/4-28 F	3.2mm	5 pk

MicroBarb®

Low-carryover connection for softwall to semi-rigid tubing

MicroBarb® provides a secure, low-carryover connection between flexible soft tubing and semi-rigid tubing. Two components ensure that the both the ID and OD of the soft tubing are firmly gripped, ensuring a secure connection. The barbed component fits inside the tube ID and creates a flat surface for connection. The threaded outer connector slips over the tubing OD and secures the barb in place, creating a female threaded flat-bottom port.

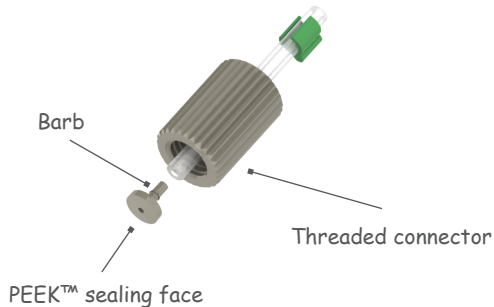

PEEK™ construction gives a chemically inert and robust connection. Simply locate the tube ID and OD in the table below to identify the MicroBarb® part number for your application. For special tubing sizes, please call the factory to see if we have a MicroBarb® combination to suit your needs.

MicroBarb® connections are also sized for common peristaltic pump tube sizes. These tubes use color-coded stops to indicate the size and type of tube.

Ordering information

MICROBARB®			
PART NUMBER	TUBE OD	TUBE ID	QTY
008MB025-208K2L ORG-BLU	0.082"	0.01"	25 pk
008MB076-208K2L	0.082"	0.03"	25 pk
008MB025-234K2L	0.092"	0.02"	25 pk
008MB051-234K2L ORG-YEL	0.092"	0.02"	25 pk
008MB051-264K2L	0.104"	0.02"	25 pk
008MB095-263K2L WHT-BLK	0.104"	0.03"	25 pk

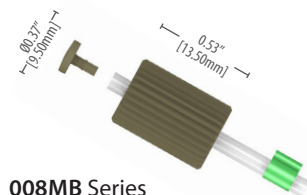

008MB Series
Microbarb® Thread to Barb

Polymers

ETFE = ethylenetetrafluoroethylene
 PTFE = polytetrafluoroethylene
 PCTFE = polychlorotrifluoroethylene
 PEEK™ = polyetheretherketone
 PP = polypropylene
 PC = polycarbonate

Tubing Extrusion

Diba Industries extrusion specializes in precision fluoropolymer, PEEK™ and other high performance tubing. Diba extruded tubing is ideal for flaring due to very tight tolerances and our lead times are days, not months! By partnering with Diba for extruding needs, customers receive:

- Precision, tight -tolerance micro bore and custom size tubing
- Real-time continuous Ultrasonic ID/OD/Wall/Concentricity/Ovality measurement
- On line data acquisition and SPC process control reports
- Customized product design and development for a wide range of thermal, mechanical and electrical properties.
- Rapid response to R & D and process variation

Almost totally inert, PTFE tubing can be used with virtually all chemicals, solvents and corrosive materials, even at elevated temperatures. It can be sterilized in-line by steam, chemical methods, or autoclaving and is available in 1/16" or 1/8" outer diameters and a range of inner bore sizes.



Ordering information

PTFE TUBING					
PART NUMBER	OD	ID	LENGTH	QTY	
008T16-030-20	1.6mm (1/16")	0.3mm (.012")	20m	ea	
008T16-030-200	1.6mm (1/16")	0.3mm (.012")	200m	ea	
008T16-050-20	1.6mm (1/16")	0.5mm (.020")	20m	ea	
008T16-050-200	1.6mm (1/16")	0.5mm (.020")	200m	ea	
008T16-080-20	1.6mm (1/16")	0.8mm (.031")	20m	ea	
008T16-080-200	1.6mm (1/16")	0.8mm (.031")	200m	ea	
008T16-100-20	1.6mm (1/16")	1.0mm (.039")	20m	ea	
008T16-100-200	1.6mm (1/16")	1.0mm (.039")	200m	ea	
008T32-150-10	3.2mm (1/8")	1.5mm (.059")	10m	ea	
008T32-150-100	3.2mm (1/8")	1.5mm (.059")	100m	ea	
008T47-032-10	4.7mm (3/16")	3.2mm (1/8")	10m	ea	
008T47-032-100	4.7mm (3/16")	3.2mm (1/8")	100m	ea	

TUBING CUTTER

PART NUMBER	DESCRIPTION	QTY
003062	Tubing cutter	ea

Trademarks

PEEK™ is a trademark of Victrex plc.
 Omnifit® Labware is a registered trademark of Diba Industries Ltd.
 Omni-Lok™ is a trademark of Diba Industries Ltd.
 Click-N-Seal® is a registered trademark of Diba Industries Inc.
 Microbarb® is a registered trademark of Diba Industries Inc.
 Dibafit™ is a trademark of Diba Industries Inc.

You love our standard components Like Click-N-Seal, but did MOST of what Diba sells is custom?

That's right...Diba is best known for their support of OEM device engineers during the design phase of an instrument. When you find yourself working on the fluid handling system of your next instrument, call on Diba and enjoy the benefits of:

- Working with experienced engineers who can customize Diba capabilities to solve your unique application challenges
- Rapid prototyping through a dedicated R&D team
- Wide range of capabilities in-house for precision machining and shaping polymers and metals
- Full documentation support through our ISO 9001 QMS system
- Real-time transition to manufacturing when design phase is complete
- Manufacturing at company plants in US, Europe or Asia

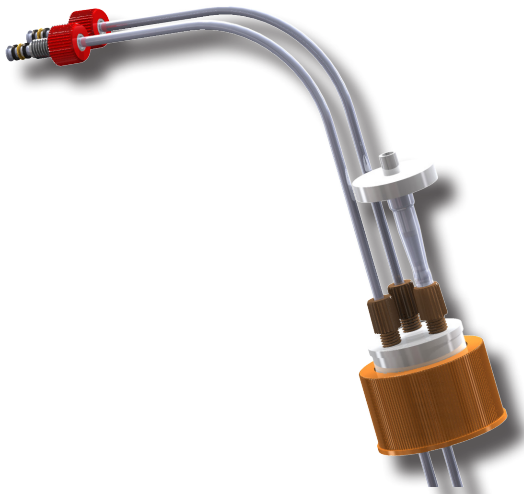
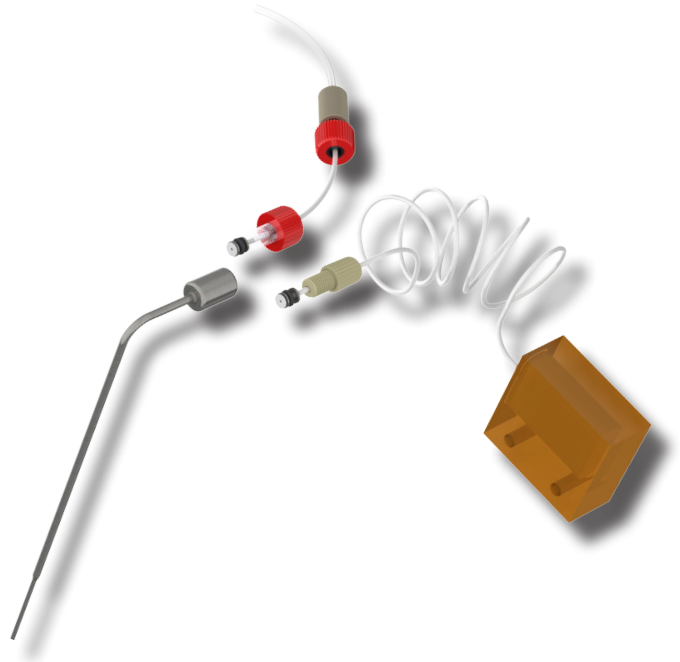

Diba offers a range of product capabilities, including:

- Connection systems including our range of patented Click-N-Seal fittings and Omni-Lok fittings for use with ferrules, flares or barbed connections
- Tubing assemblies with Diba's proprietary flares (we make more than 2 million per year.)
- Custom probe design including drawn tips, Teflon-lined, coated or DP3 polished IDs
- Fluid heaters for in-line heating
- Custom bottle caps with check valves or free spinning cores so tubes won't become twisted
- Custom syringes



North America

Diba Industries Inc.
4 Precision Road
Danbury, CT 06810 USA
Tel: +1 203-744-0773
Fax: +1 203-744-0663
salesdept@dibaind.com

VAS Integrated
600 Four Rod Road
Berlin, CT 06037 USA
Tel: +1 860-748-4058
Fax: +1 860-540-1040
support@vasintegrated.com

Europe

Diba Industries Ltd.
2 College Park
Coldhams Lane
Cambridge, CB1 3HD, UK
Tel: +44 (0) 1223 472801
Fax: +44 (0) 1223 416787
sales@dibaind.com

China

Diba Industries Inc.
Halma International Ltd.
Shanghai Representative Office
Room 1106, Metro Plaza, No555
Lou Shan Guan Road,
Shanghai, PRC 200051, CHINA
Tel: +86 21-6016-7622
Fax: +86 21-5206-8191
chinasales@dibaind.com

www.dibaind.com A HALMA COMPANY